

PART/PRINT NO.
AKS11400

PART DESCRIPTION
20X6" RISER

REVISION
003

DATE
2/17/03

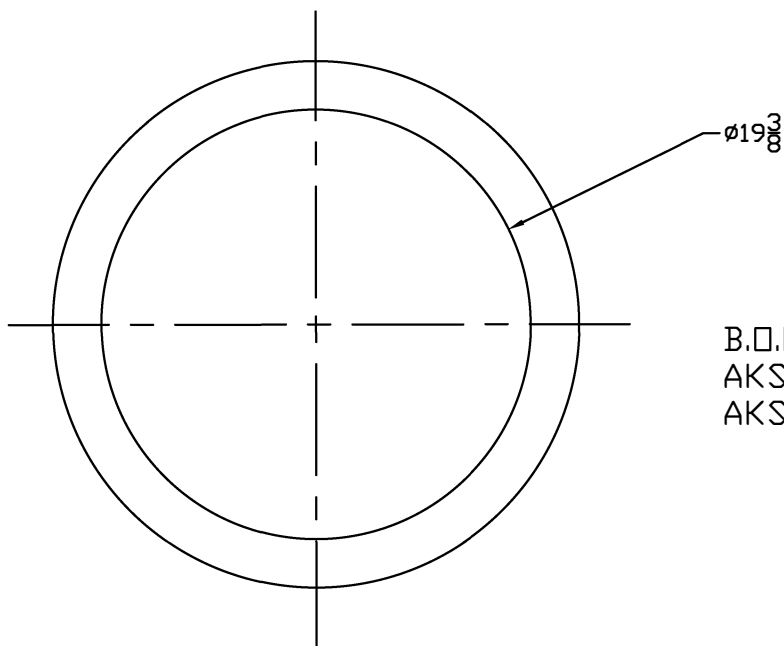
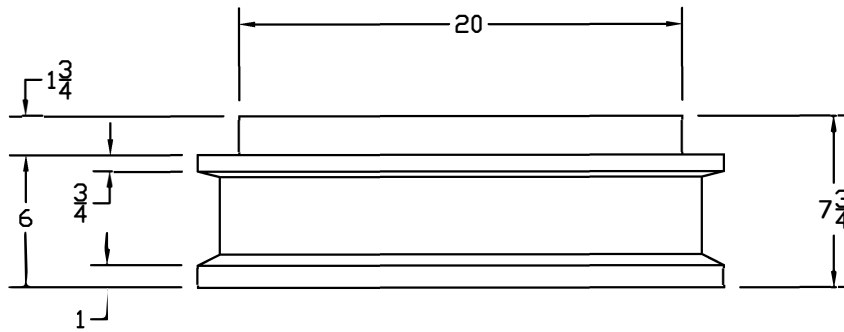
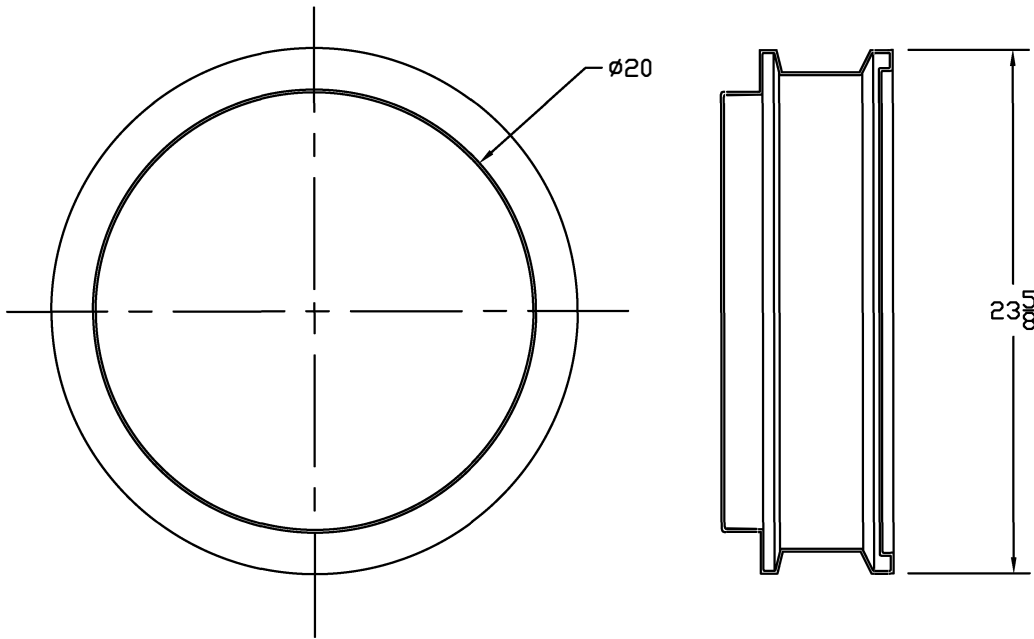

B.O.M
AKS11400 6" RISER
AKS12851 GASKET PACK/6-12" RISER



DRAINAGE
SOLUTIONS, INC

(317) 346-4110

www.drainagesolutionsinc.com

DRAWN
M.OLIVAREZ

MATERIAL
POLYPROPYLENE

TOLERANCE
+/-0.250 UNLESS SPECIFIED OTHERWISE

SIGNATURE